

DATA SHEET - SERVICE MANUAL

APPLICATION

Directional spool valves type **WE10...** electrically operated are intended for change in direction of fluid flow in a hydraulic system and thus it allows to change direction of movement of a receiver - mostly piston rod of a cylinder or hydraulic motor as well to use functions: *on* and *off*. These directional spool valves are used for subplate mounting in any position in a hydraulic system.

Directional spool valve is complied with the regulations of directive **2006/95/WE** for the following voltages:

- 50 – 250 V for AC
- 75 – 250 V for DC

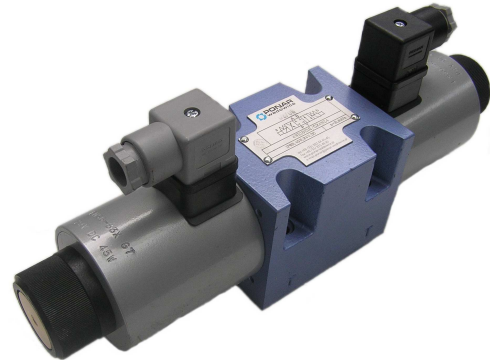

DESCRIPTION OF OPERATION

4WE10 G -12/G24NZ4

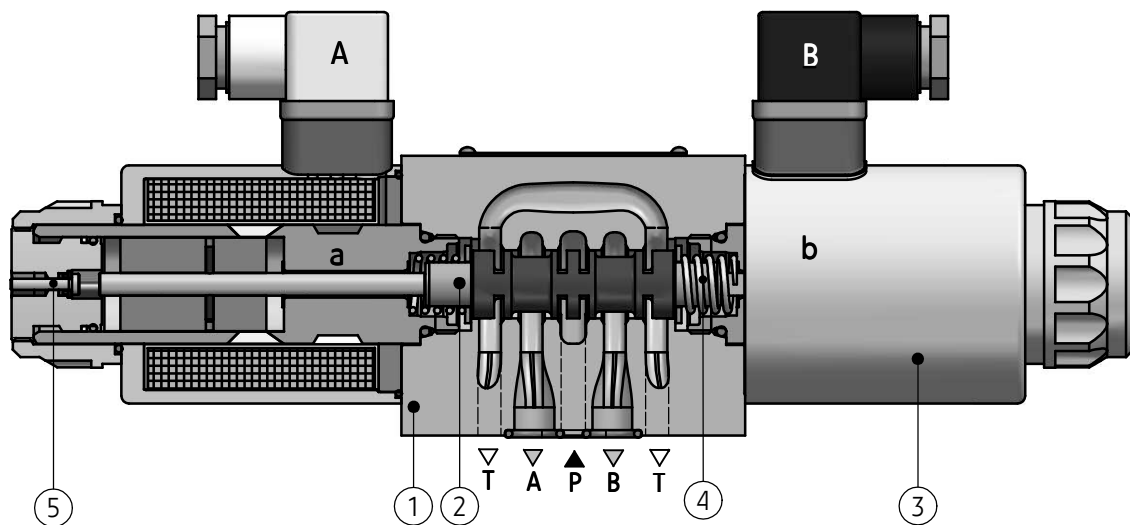

Main elements of directional spool valve type **WE10...** are: housing (1), solenoids (3), control spool (2), centering springs (4) and manual overrides (5).

The spool (2) is shifted when it is moved into one of end positions by the force of solenoid (3) affecting it. The return of the spool into neutral position and centering are secured by the centering springs (4). The shape of the spool (control edge spacing) affects the configuration of connections among the ports: **A, B, P** and **T**.

In case of emergency, the spool can be shifted manually by means of the override (5) – only for version with manual override.

When the situation is anticipated, directional spool valve must be mounted in the way as to be available.

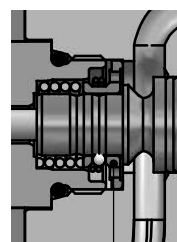

6

WE10...-12/OF... - only for spools: **A, C, D**. Two-position directional spool valve without return springs with detent. The spool (2) is positioned and supported with detent (6), and its shift results from supplying voltage to one solenoid (3).

DESCRIPTION OF OPERATION

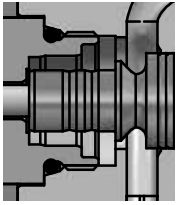

WE10...-12/O... - only for spools: **A, C, D**.
Two-position directional spool valve without return springs. The spool is positioned and supported with attached solenoid. There is no neutral position as the spool is not positioned.

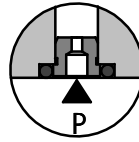

WE10...-12/...B... - directional spool valve designation like that, has throttle insert in port **P**.

TECHNICAL DATA

| | | | | | |
|---|--|------------------------------|------------------------------|--|------------------------------|
| Hydraulic fluid | mineral oil | | | | |
| Required filtration | up to 16 µm | | | | |
| Recommended filtration | up to 10 µm | | | | |
| Nominal fluid viscosity | 37 mm ² /s at temperature 55 °C | | | | |
| Viscosity range | 2,8 up to 380 mm ² /s | | | | |
| Fluid temperature range (in a tank) | recommended | 40 °C up to 55 °C | | | |
| | max | -20 °C up to +70 °C | | | |
| Ambient temperature range | - 20 °C up to +50 °C | | | | |
| Maximum operating pressure | ports P, A, B | 31,5 MPa | | | |
| | port T | 21 MPa | | | |
| Flow section in central position schemes on page 3 | spool | Q | W | V | |
| | flow direction | A → T B → T | A → T B → T | A → T B → T | P → A P → B |
| | flow section | 5,5 mm ² | 2,5 mm ² | 11 mm ² | 10 mm ² |
| Switching time | ON | up to 60 ms | | | |
| | OFF | up to 40 ms | | | |
| Maximum switching frequency | 15000 on/h | | | | |
| Weight | with 1 solenoid | max 4,6 kg | | | |
| | with 2 solenoids | max 6,2 kg | | | |
| Supply voltage for solenoids | DC | | | AC (plug-in connector with rectifier) | |
| | 12V | 24V | 110V | 230V - 50Hz | 110V - 50Hz |
| Supply voltage tolerances | ±10% | | | | |
| Power requirement (DC) | 45 W | | | | |
| Insulation | IP 65 | | | | |
| Solenoid coil temperature | max 150 °C | | | | |

ASSEMBLY AND APPLICATION REQUIREMENTS

1. Only valve working properly and suitably installed may be connected to an electric system. Only skilled workers are allowed to connect and disconnect electric system.
2. Ground connection (⏏) must be connected with protective earth wire (PE ⏏) in supply system according to appropriate instructions.
3. It is forbidden to apply directional spool valve if the supply cable in the gland of plug-in-connector is not properly tightened.
4. It is forbidden to apply directional spool valve if the plug-in-connector is not properly tightened to the solenoid socket and is not secured by screwing bolt tightly.
5. Due to heating solenoid coils, directional spool valves should be placed in order to eliminate the possibility of incidental touch while using, or, they should be equipped with the coil covers (in accordance with the European standards PN - EN ISO 13732-1 and PN - EN 982).

SCHEMES

Graphic symbols for 3- position directional spool valves

WE10...-1X/...

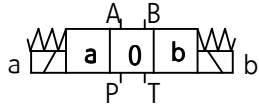

Graphic symbols for 2- position directional spool valves

WE10...A-1X/...

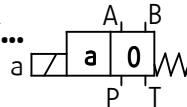

WE10...B-1X/...

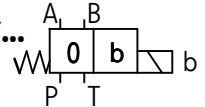

Graphic symbols for spools

working and indirect positions

working positions

working and indirect positions

working positions

working and indirect positions

working positions

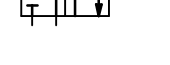
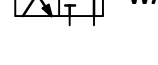
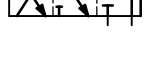
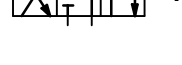
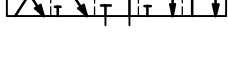
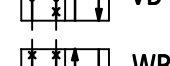
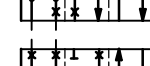
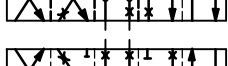
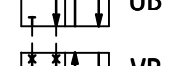
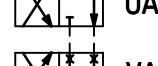
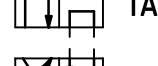
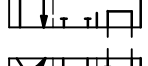
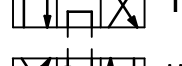
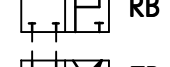
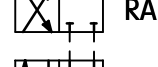
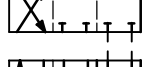
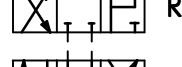
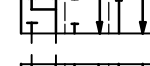
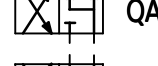
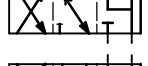
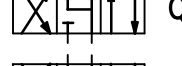
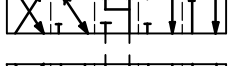
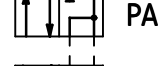
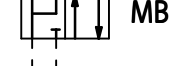
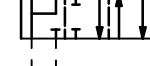
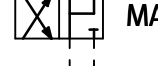
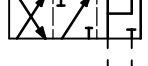
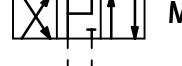
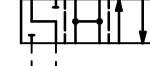
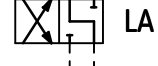
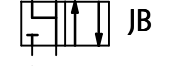
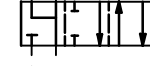
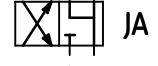
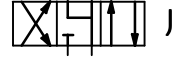
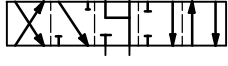
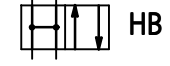
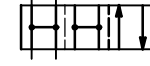
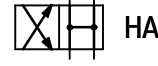
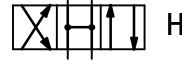
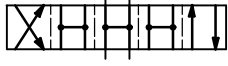
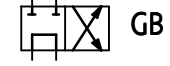
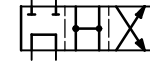
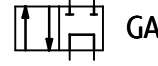
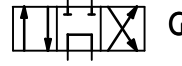
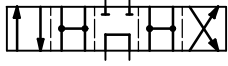
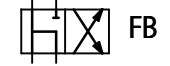
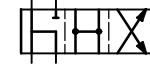
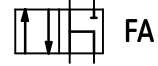
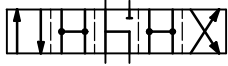
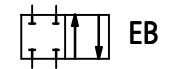
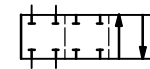
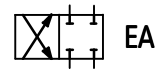
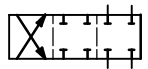
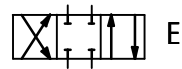
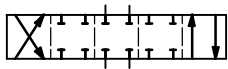
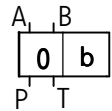
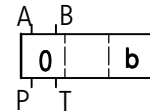
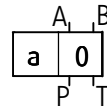
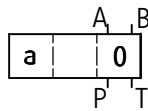
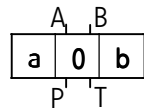
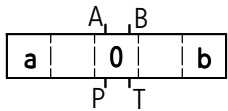

NOTES:

Flow section in central position for spools:
Q, W, V - according to page 2

SCHEMES

Graphic symbols for 2- position directional spool valves

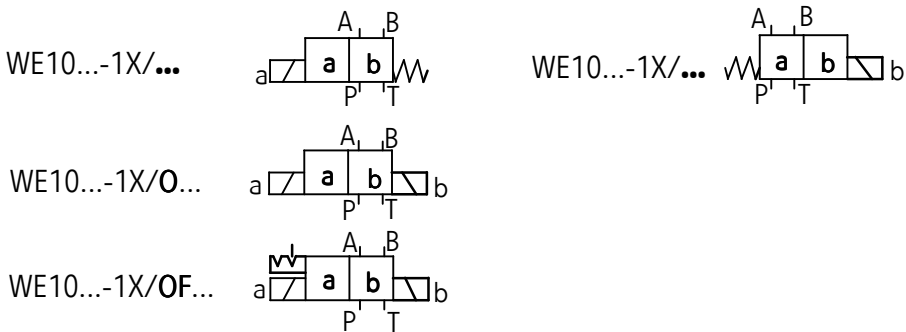

Graphic symbols for spools

working and indirect positions

working positions

working and indirect positions

working positions

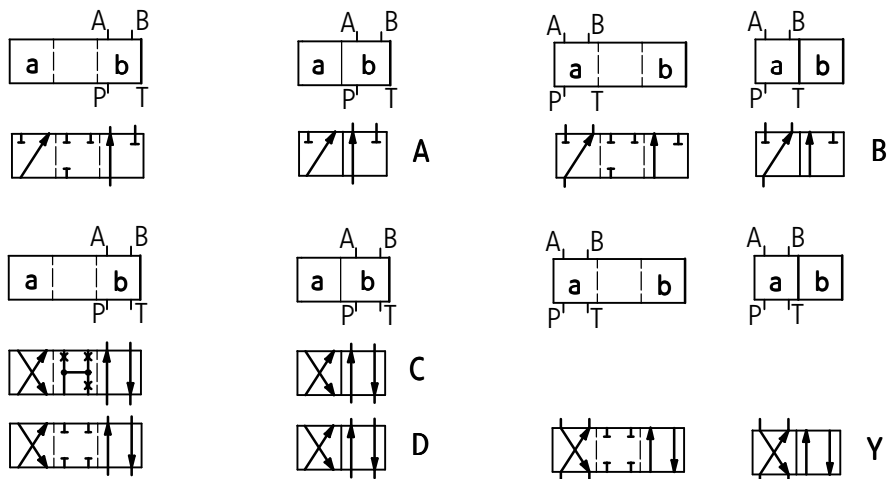

OVERALL AND CONNECTION DIMENSIONS

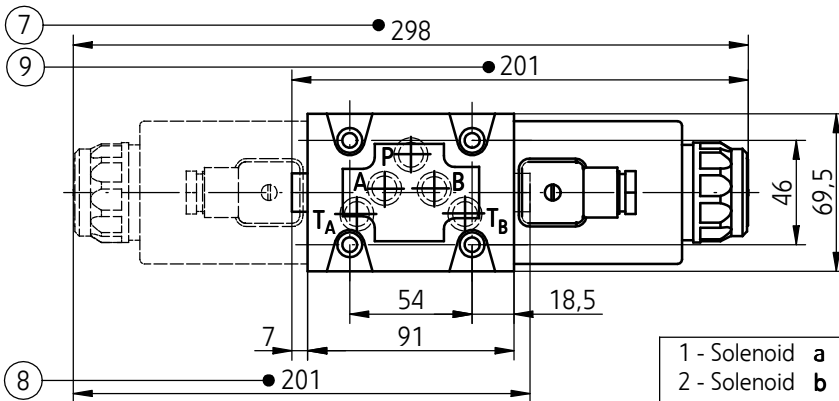
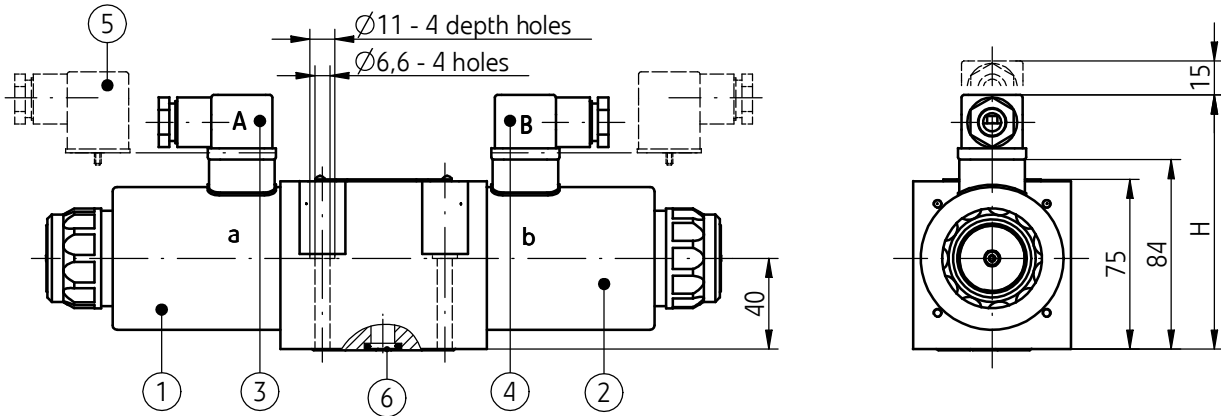

| electrical connection type | | dimension H |
|---|--|-------------|
| plug-in-connectors ISO 4400 type | control voltage - DC 12V, 24V, 110V | 112 |
| plug-in-connectors ISO 4400 type with rectifier | control voltage - AC 110V, 230V | 119 |

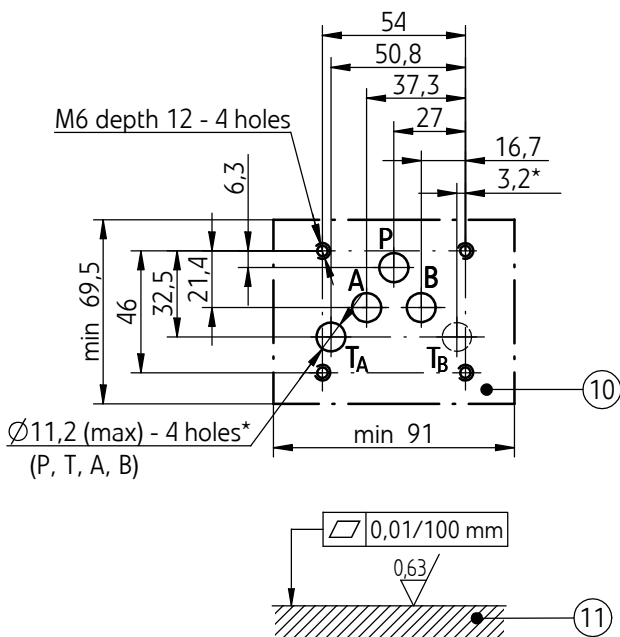

- 1 - Solenoid a
- 2 - Solenoid b
- 3 - Plug-in-connector A (ISO 4400 type)
- 4 - Plug-in-connector B (ISO 4400 type)
- 5 - Plug-in-connector (ISO 4400 type) with rectifier
- 6 - O-ring 12 x 2 - 5 pcs/kit (P, TA, TB, A, B)
- 7 - Directional spool valve size with 2 solenoids - a, b
 - 3-position directional spool valve springs centered (spool schemes: E,F,G,H, J, L,M,Q,R,T,U,V,W - according to page 3)
 - 2-position directional spool valve without return springs
 - 2-position directional spool valve without springs and with detent (spool schemes: A, C, D - according to page 4)
- 8 - Directional spool valve size with 1 solenoid - a
 - 2-position springs centered (spool schemes: A, C, D, EA, FA, GA, HA, JA, LA, MA, PA, QA, RA, TA, UA, VA, WA - according to page 3 and 4)
- 9 - Directional spool valve size with 1 solenoid - b
 - 2-position springs centered (spool schemes: B, Y, EB, FB, GB, HB, JB, LB, MB, PB, QB, RB, TB, UB, VB, WB - according to page 3 and 4)
- 10 - Porting pattern for directional spool valve configuration of connection holes in accordance with the following standards:
 - CETOP RP 121H - identified by CETOP 4.2-4-05-320 (nominal size CETOP 05)
 - ISO 4401 - identified by ISO 4401-05-04-0-94
- (*) - connection with 1 hole T from the side of the hole A or B is enough - holes TA and TB are connected with the port in the housing of directional spool valve mounting bolts M6 x 50 - 10.9 in accordance with PN-EN ISO 4762 - 4 pcs/kit tightening torque Md = 15 Nm.
- 11 - Subplate surface required

PERFORMANCE CURVES

measured at viscosity $\nu = 41 \text{ mm}^2/\text{s}$ and temperature $t = 50^\circ\text{C}$

Flow resistance curves

Characteristic curves $\Delta p(Q)$ for directional spool valves type WE10...-12/... for various spool types

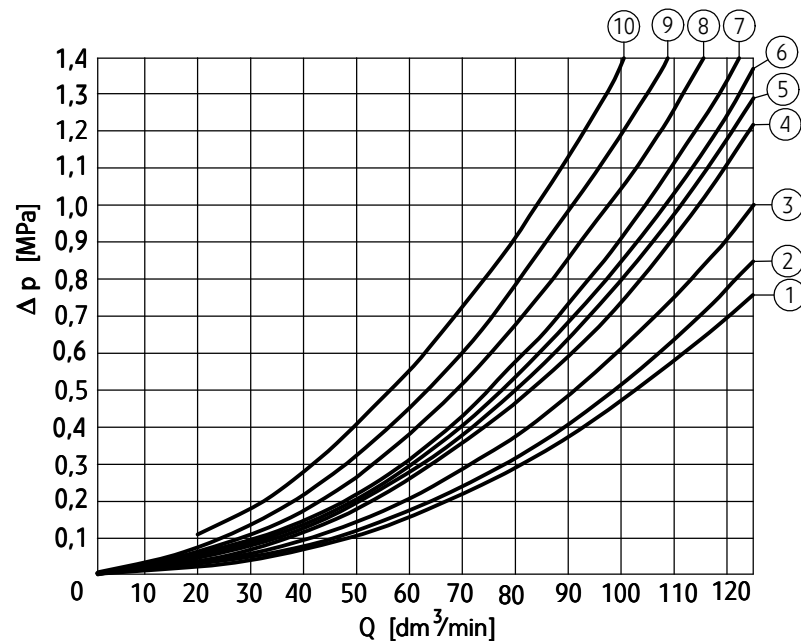

| Spool type schemes according to page 3, 4 | Performance diagram number | | | |
|---|----------------------------|-------|-------|-------|
| | flow direction | | | |
| | P → A | P → B | A → T | B → T |
| A, B | 3 | 3 | - | - |
| C | 3 | 3 | 4 | 5 |
| D, Y | 5 | 5 | 6 | 6 |
| E | 1 | 1 | 4 | 4 |
| F | 2 | 3 | 7 | 4 |
| G | 3 | 3 | 6 | 7 |
| H | 1 | 1 | 6 | 7 |
| J | 1 | 1 | 3 | 3 |
| L | 2 | 2 | 3 | 5 |
| M | 1 | 1 | 4 | 5 |
| P | 4 | 2 | 5 | 7 |
| Q | 1 | 2 | 1 | 3 |
| R | 3 | 6 | 4 | - |
| T | 3 | 3 | 6 | 7 |
| U, V | 2 | 2 | 3 | 3 |
| W | 2 | 2 | 4 | 5 |

| Spool type | Performance diagram number | | | | | |
|----------------------------------|----------------------------|-------|-------|-------|-------|-------|
| | flow direction | | | | | |
| central position scheme - page 3 | P → A | P → B | P → T | A → T | B → T | B → A |
| F | 4 | - | 9 | 9 | - | - |
| P | - | 5 | 10 | - | 8 | - |
| G, T | - | - | 9 | - | - | - |
| H | - | - | 3 | - | - | - |

| Spool type | Performance diagram number | | | | | |
|----------------------------------|----------------------------|-------|-------|-------|-------|-------|
| | flow direction | | | | | |
| shifted position scheme - page 3 | P → A | P → B | P → T | A → T | B → T | B → A |
| R | - | - | - | - | - | 9 |

Flow limit curves

Characteristic curves $p-Q$ for directional spool valves type WE10...-12/.. with DC solenoids for various spool types

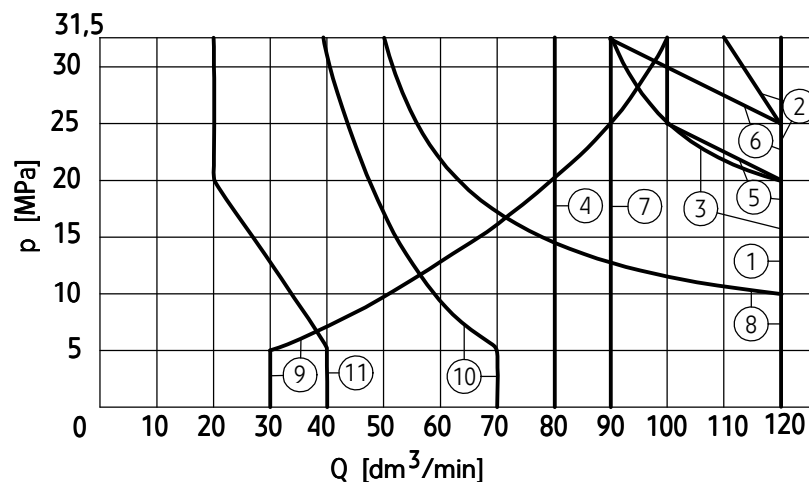

| Spool type schemes according to page 3, 4 | Performance diagram number |
|---|----------------------------|
| C, C/O, C/OF D, D/O, D/OF, Y M | 1 |
| E | 2 |
| J, | 3 |
| H, Q, W | 4 |
| R | 5 |
| L | 6 |
| U | 7 |
| A, A/OF, B | 8 |
| V | 9 |
| F, P, G | 10 |
| T | 11 |

NOTES:

Above flow limits are related to symmetrical flow through all ports i.e. if the oil flows from port P to port A, then the same flow rate flows out from

port B to port T (applied to directional control valves with 4 service ports). Degree of asymmetry affects adversely the parameters.

HOW TO ORDER

| | | | | | | | | | | | | | | | | |
|--|-----------|-----------|--|---|--|--|--|--|--|--|--|--|--|--|--|----------|
| | WE | 10 | | / | | | | | | | | | | | | * |
|--|-----------|-----------|--|---|--|--|--|--|--|--|--|--|--|--|--|----------|

Number of service ports

3-way - for spools A, B = **3**

4-way - for the other spools = **4**

Nominal size (NS)

NS10 = **10**

Spool type

spool schemes - according to **page 3, 4**

Series number

(10-19) - connection and installation dimensions unchanged = 1X

series 12 = **12**

Spool positioning

spring centering = **no designation**

without springs return = **0**

without springs return with detent = **OF**

Control voltage for solenoids

12V DC = G12

24V DC = **G24**

110V DC = G110

110V AC 50Hz (plug-in-connector with rectifier) = W110R

230V AC 50Hz (plug-in-connector with rectifier) = **W230R**

Manual override

solenoids without manual override = no designation

solenoids with manual override = **N**

Electrical connection

plug-in-connector ISO 4400 type without LED = **Z4**

plug-in-connector ISO 4400 type with LED = Z4L

Throttle insert (in port P)

without throttle insert = **no designation**

throttle insert ϕ 0,8 = B 08

throttle insert ϕ 1,0 = B 10

throttle insert ϕ 1,2 = B 12

throttle insert ϕ 3,0 = B 30

Sealing

NBR (for fluids on mineral oil base) = **no designation**

FPM (for fluids on phosphate ester base) = **V**

Further requirements in clear text (to be agreed with the manufacturer)

NOTES:

Directional spool valve should be ordered according to the above coding.

The symbols in bold are preferred versions in short delivery time.

Coding example: 4WE10 E – 12/G24 N Z4 B08

EXAMPLE OF APPLICATION IN HYDRAULIC SYSTEM

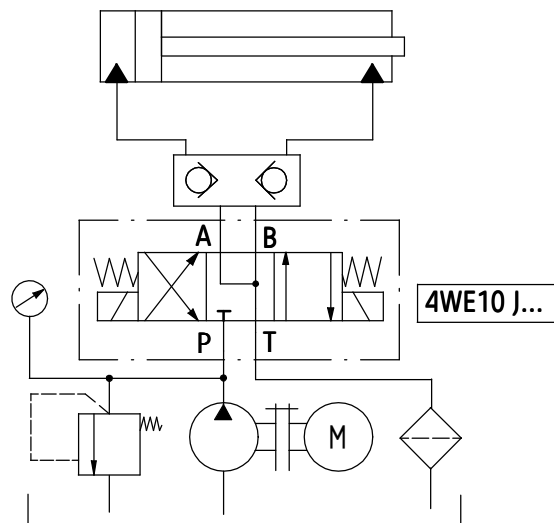

SUBPLATES AND MOUNTING BOLTS

Subplates must be ordered according to the data sheet **WK 496 520**. Subplates:

G 66/01 - threaded connection G 3/8

G 67/01 - threaded connection **G 1/2**

G 89/01 - threaded connection G1/4

G 67/02 - threaded connection M22 x1,5

Subplates and bolts fixing directional valve **M6 x 50 - 10,9** in accordance with **PN-EN ISO 4762** - 4 pcs/kit must be ordered separately.

Tightening torque for bolts **Md = 15 Nm**

PONAR Wadowice S.A.
ul. Wojska Polskiego 29
34-100 Wadowice
tel. +48 33 488 21 00
fax. +48 33 488 21 03
www.ponar-wadowice.pl

 **PONAR**[®]
wadowice